



# DOOR & DRAWER INSTALL SPECIFICATIONS



Model # 53830-S Shown



Model # 53930S Shown

## GENERAL INFORMATION

**INSTALLER:** Leave these instructions with consumer.  
**CONSUMER:** Retain for future reference.

### WARNING

This unit is to be installed by a qualified, professional service technician.

**Important:** READ THESE INSTRUCTIONS CAREFULLY BEFORE STARTING INSTALLATION

- When installing this unit directly below another unit, only install with Fire Magic built-in products.
- For proper installation, be sure to use the correct cutout dimensions as specified for your specific model number.
- It is recommended that silicon caulking (not supplied) is applied around the back of the door/drawer cabinet trim before sliding the cabinet assembly into the opening.
- Some models may include an additional owner's manual.
- **When used for propane cylinder storage, a louvered door model is required.**

**CAUTION:** Make sure the enclosure is properly vented. See your grill owner's manual for venting requirements, or consult your local codes.

### **WHEN USING A PROPANE TANK CYLINDER:**

- **Never locate a cylinder under or near a grill unless sufficient ventilation and shielding is provided to prevent any heating of the cylinder regulator and hose.** Refer to any additional instructions included with your door (and/or your grill owner's manual) for the required installation method of propane tank cylinders.
- **FOLLOW ALL THE SAFETY WARNING AND INFORMATION FOUND IN THESE INSTRUCTIONS, ON YOUR PROPANE CYLINDER, AND IN YOUR GRILL OWNER'S MANUAL ABOUT SAFE STORAGE AND USE OF PROPANE GAS.**

ROBERT H. PETERSON CO. • 14724 East Proctor Avenue • City of Industry, CA 91746

# INSTALLATION GUIDELINES

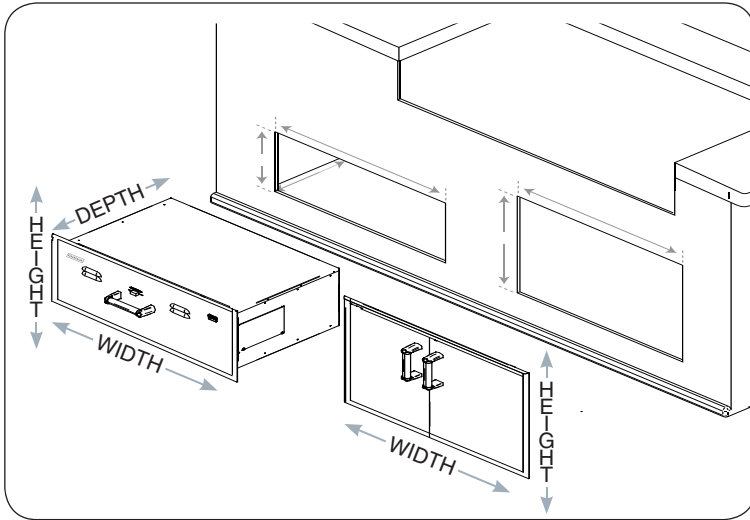

Fig. 2-1 Cut-out Dimension Guide

For proper installation, be sure to use the correct cutout dimensions as specified for your specific model number. Locate your model on the following pages for dimensions, and reference Fig. 2-1 for proper orientation.

## DRAWER

Before installing your drawer, remove the drawer from its base by completely pulling it out. Release the drawer from the drawer slides by pressing the black lever down on the right side, and up on the left side (Fig 2-2). Then pull outward on the drawer until it comes free of the runners.

1. In order to properly support the weight of your drawer, it is necessary to provide a secure, level surface in the rear of the unit. (See Fig 2-3) This may be accomplished by using bricks, 2 X 4's, etc. Be sure that the height of this rear support is  $\frac{1}{8}$ " higher than that of the front opening support, so that your drawer sits level.
2. Slide in and fasten the unit securely into the island enclosure using the appropriate hardware for your enclosure (not supplied) through the installation screw slots in the top and bottom of the unit.
3. To re-attach the drawer; extend the drawer slides completely and align the drawer into the slides, pushing the drawer closed. Open the drawer to verify that it has locked in place.

## DOOR

Slide in and fasten the unit securely into the island enclosure using the appropriate hardware for your enclosure (not supplied) through the installation screw slots in the top and bottom of the unit.

### For doors with propane tank trays:

To use, simply open the door, pull out the sliding cylinder tray, place your cylinder on the tray and push the tray back in. The cylinder is now ready for connection to your grill.

**Important:** Refer to any additional instructions included with your door for the required installation method of propane tank cylinders.

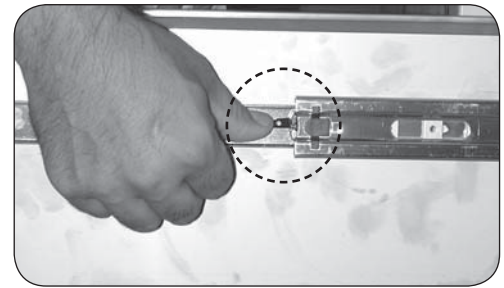

Fig. 2-2 Releasing drawer from slides

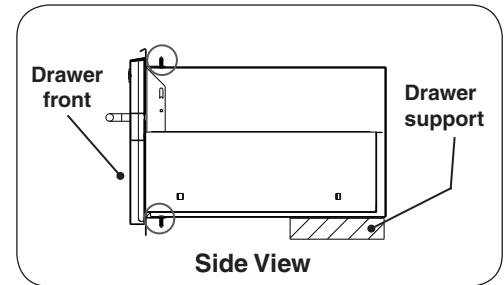

Fig. 2-3 Drawer Installation (Side View)

# FLUSH-MOUNTED DOORS & DRAWERS

Cut-out is height x width x depth



**DOUBLE DOORS WITH DUAL DRAWERS**  
**MODEL:** 53930S-22  
**CUT-OUT:** 21" x 30 1/2" x 20 1/2"

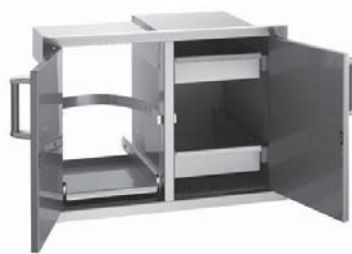

**DOUBLE DOORS WITH TANK TRAY & DUAL DRAWERS**  
**MODEL:** 53930S-12T  
**CUT-OUT:** 21" x 30 1/2" x 20 1/2"



**MASONRY DRAWER WITH TRAY**  
**MODEL:** 53830-S  
**CUT-OUT:** 14 1/2" x 32 1/4" x 22"



**ELECTRIC WARMING DRAWER**  
**MODEL:** 53830-SW  
**CUT-OUT:** 14 1/2" x 32 1/4" x 22"



**TRIPLE DRAWERS WITH TRAY**  
**MODEL:** 53803  
**CUT-OUT:** 26 1/4" x 14 1/2" x 20 1/2"



**DOUBLE DRAWERS WITH TRAY**  
**MODEL:** 53802  
**CUT-OUT:** 15 3/4" x 14 1/2" x 20 1/2"



**SINGLE ACCESS DOOR\***  
**MODEL:** 53924-SL  
**CUT-OUT:** 25" x 17 1/2"



**DOUBLE ACCESS DOORS**  
**MODEL:** 53934S  
**CUT-OUT:** 15" x 30"



**SINGLE ACCESS DOOR W/ CABINET & DOUBLE DRAWERS**  
**MODEL:** 53810S  
**CUT-OUT:** 18 1/2" x 30" x 26"

\* Available in left or right hinge

# FLUSH-MOUNTED DOORS & DRAWERS (cont.)

Cut-out is height x width x depth

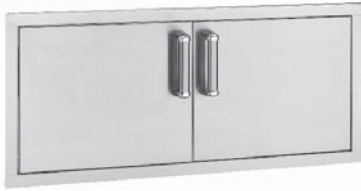

**DOUBLE ACCESS DOORS**  
**MODEL:** 53938S  
**CUT-OUT:** 16" x 39"



**SINGLE DOOR WITH DUAL DRAWERS\***  
**MODEL:** 53820-SR  
**CUT-OUT:** 21" x 14 1/2" x 20 1/2"



**SINGLE DRAWER WITH TRAY**  
**MODEL:** 53801  
**CUT-OUT:** 5 1/4" x 14 1/2" x 20 1/2"



**DOUBLE ACCESS DOORS**  
**MODEL:** 53930S  
**CUT-OUT:** 21" x 30"



**SINGLE ACCESS DOOR\***  
**MODEL:** 53920-SL  
**CUT-OUT:** 21" x 14 1/2"



**SINGLE ACCESS DOOR\***  
**MODEL:** 53917-SR  
**CUT-OUT:** 18" x 24 1/2"



**SINGLE ACCESS DOOR\***  
**MODEL:** 53914-SR  
**CUT-OUT:** 15" x 20 1/2"



**DOUBLE ACCESS DOORS WITH LOUVERS**  
**MODEL:** 53930S-1  
**CUT-OUT:** 21" x 30"



**ACCESS DOORS AND DOUBLE DRAWERS**  
**MODEL:** 53816S  
**CUT-OUT:** 18 1/2" x 36 1/2" x 26"

*Also available: (not shown)*

<b>MODEL:</b> 53914-SL	<b>CUT-OUT:</b> 15" x 20 1/2"
<b>MODEL:</b> 53917-SL	<b>CUT-OUT:</b> 18 1/2" x 24 1/2"
<b>MODEL:</b> 53924-SR	<b>CUT-OUT:</b> 25" x 17 1/2"
<b>MODEL:</b> 53920-SR	<b>CUT-OUT:</b> 21" x 14 1/2"
<b>MODEL:</b> 53820-SL	<b>CUT-OUT:</b> 21" x 14 1/2" x 20 1/2"
<b>MODEL:</b> 53930S-12	<b>CUT-OUT:</b> 21" x 30 1/2" x 20 1/2"
<b>MODEL:</b> 53820-TSR or TSL	<b>CUT-OUT:</b> 21" x 14 1/2" x 20 1/2"

\* Available in left or right hinge

# PREMIUM DOORS & DRAWERS

Cut-out is **height x width x depth**



**ELECTRIC WARMING DRAWER**  
**MODEL:** 43830-SW  
**CUT-OUT:** 13" x 31" x 20 1/2"



**MASONRY DRAWER WITH TRAY**  
**MODEL:** 43830-S  
**CUT-OUT:** 13" x 31" x 20 1/2"



**DOUBLE DRAWERS WITH TRAY**  
**MODEL:** 43802  
**CUT-OUT:** 15 3/4" x 14 1/2" x 20 1/2"



**DOUBLE ACCESS DOORS**  
**MODEL:** 43934S  
**CUT-OUT:** 15" x 30"



**TRIPLE DRAWERS WITH TRAY**  
**MODEL:** 43803T  
**CUT-OUT:** 26 1/4" x 14 1/2" x 20 1/2"



**SINGLE ACCESS DOOR WITH TANK TRAY AND LOUVERS\***  
**MODEL:** 43820-TSL  
**CUT-OUT:** 21" x 14 1/2" x 20 1/2"

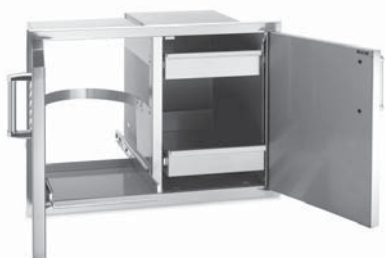

**DOUBLE DOORS WITH TANK TRAY, LOUVERS, AND DUAL DRAWERS**  
**MODEL:** 43930S-12T  
**CUT-OUT:** 21" x 30 1/2" x 20 1/2"



**ACCESS DOORS AND DOUBLE DRAWERS**  
**MODEL:** 43816S  
**CUT-OUT:** 18 1/2" x 36 1/2" x 26"

\* Available in left or right hinge

# PREMIUM DOORS & DRAWERS (cont.)

Cut-out is height x width x depth



**SINGLE DOOR WITH DUAL DRAWERS\***  
**MODEL:** 43820-SL  
**CUT-OUT:** 21" x 14 1/2" x 20 1/2"



**SINGLE ACCESS DOOR\***  
**MODEL:** 43920-SR  
**CUT-OUT:** 21" x 14 1/2"



**DOUBLE ACCESS DOORS**  
**MODEL:** 43930S  
**CUT-OUT:** 21" x 30"



**SINGLE DRAWER WITH TRAY**  
**MODEL:** 43801  
**CUT-OUT:** 5 1/4" x 14 1/2" x 20 1/2"



**SINGLE ACCESS DOOR\***  
**MODEL:** 43914-SR  
**CUT-OUT:** 15" x 20 1/2"



**SINGLE ACCESS DOOR\***  
**MODEL:** 43917-SR  
**CUT-OUT:** 18" x 24 1/2"



**DOUBLE DOORS WITH 2 DUAL DRAWERS**  
**MODEL:** 43930S-22  
**CUT-OUT:** 21" x 30 1/2" x 20 1/2"



**DOUBLE ACCESS DOORS WITH LOUVERS**  
**MODEL:** 43930S-1  
**CUT-OUT:** 21" x 30"



**SINGLE ACCESS DOOR W/ CABINET & DOUBLE DRAWERS**  
**MODEL:** 43810S  
**CUT-OUT:** 18 1/2" x 30" x 26"

Also available: (not shown)

- |                              |   |
|------------------------------|---|
| <b>MODEL:</b> 43914-SL       | <b>CUT-OUT:</b> 15" x 20 1/2"           |
| <b>MODEL:</b> 43917-SL       | <b>CUT-OUT:</b> 18" x 24 1/2"           |
| <b>MODEL:</b> 43924-SR or SL | <b>CUT-OUT:</b> 25" x 17 1/2"           |
| <b>MODEL:</b> 43920-SL       | <b>CUT-OUT:</b> 21" x 14 1/2"           |
| <b>MODEL:</b> 43938S         | <b>CUT-OUT:</b> 16" x 39"               |
| <b>MODEL:</b> 43930S-12      | <b>CUT-OUT:</b> 21" x 30 1/2" x 20 1/2" |
| <b>MODEL:</b> 43820-TSR      | <b>CUT-OUT:</b> 21" x 14 1/2" x 20 1/2" |

\* Available in left or right hinge

# SELECT DOORS & DRAWERS

Cut-out is height x width x depth



**ELECTRIC WARMING DRAWER**  
**MODEL:** 33830-SW  
**CUT-OUT:** 13" x 31" x 20 1/2"



**MASONRY DRAWER WITH TRAY**  
**MODEL:** 33830-S  
**CUT-OUT:** 13" x 31" x 20 1/2"



**DOUBLE ACCESS DOORS**  
**MODEL:** 33930S  
**CUT-OUT:** 21" x 30"



**TRIPLE DRAWERS WITH TRAY**  
**MODEL:** 33803  
**CUT-OUT:** 26 1/4" x 14 1/2" x 20 1/2"



**DOUBLE DRAWERS WITH TRAY**  
**MODEL:** 33802  
**CUT-OUT:** 15 3/4" x 14 1/2" x 20 1/2"



**DOUBLE DOORS WITH TANK TRAY, LOUVERS, AND DUAL DRAWERS**  
**MODEL:** 33930S-12T  
**CUT-OUT:** 21" x 30 1/2" x 20 1/2"



**SINGLE DOOR WITH DUAL DRAWERS\***  
**MODEL:** 33820-SR  
**CUT-OUT:** 21" x 14 1/2" x 20 1/2"



**ACCESS DOORS AND DOUBLE DRAWERS**  
**MODEL:** 33816S  
**CUT-OUT:** 18 1/2" x 36 1/2" x 26"

\* Available in left or right hinge



## SELECT DOORS & DRAWERS (cont.)

Cut-out is height x width x depth



**SINGLE ACCESS DOOR\***  
**MODEL:** 33914-SR  
**CUT-OUT:** 15" x 20 ½"



**DOUBLE DOORS WITH 2 DUAL DRAWERS**  
**MODEL:** 33930S-22  
**CUT-OUT:** 21" x 30 ½" x 20 ½"



**SINGLE ACCESS DOOR\***  
**MODEL:** 33920-SR  
**CUT-OUT:** 21" x 14 ½"



**SINGLE ACCESS DOOR WITH TANK TRAY AND LOUVERS\***  
**MODEL:** 33820-TSL  
**CUT-OUT:** 21" x 14 ½" x 20 ½"



**SINGLE ACCESS DOOR\***  
**MODEL:** 33917-SR  
**CUT-OUT:** 18" x 24 ½"



**SINGLE DRAWER WITH TRAY**  
**MODEL:** 33801  
**CUT-OUT:** 5 ¼" x 14 ½" x 20 ½"



**SINGLE ACCESS DOOR W/ CABINET & DOUBLE DRAWERS**  
**MODEL:** 33810S  
**CUT-OUT:** 18 ½" x 30" x 26"

*Also available: (not shown)*

**MODEL:** 33914-SL

**CUT-OUT:** 15" x 20 ½"

**MODEL:** 33917-SL

**CUT-OUT:** 18" x 24 ½"

**MODEL:** 33920-SL

**CUT-OUT:** 21" x 14 ½"

**MODEL:** 33924-SR or SL

**CUT-OUT:** 25" x 17 ½"

**MODEL:** 33938S

**CUT-OUT:** 16" x 39"

**MODEL:** 33820-SL

**CUT-OUT:** 21" x 14 ½" x 20 ½"

**MODEL:** 33820-TSR

**CUT-OUT:** 21" x 14 ½" x 20 ½"

**MODEL:** 33930S-12

**CUT-OUT:** 21" x 30 ½" x 20 ½"

\* Available in left or right hinge



# LEGACY DOORS & DRAWERS

Cut-out is height x width x depth



**MASONRY DRAWER WITH TRAY**  
**MODEL:** 23830-S  
**CUT-OUT:** 13" x 31" x 20 1/2"



**SINGLE ACCESS DOOR**  
**MODEL:** 23917-S  
**CUT-OUT:** 17 1/2" x 24 1/2"



**SINGLE ACCESS DOOR**  
**MODEL:** 23920-S  
**CUT-OUT:** 20 1/2" x 14 1/2"



**SINGLE ACCESS DOOR (RIGHT OR LEFT) WITH TANK TRAY AND LOUVERS**  
**MODEL:** 23920-1T-S  
**CUT-OUT:** 20 1/2" x 14 1/2" x 20 1/2"



**SINGLE ACCESS DOOR WITH LOUVERS**  
**MODEL:** 23920-1-S  
**CUT-OUT:** 20 1/2" x 14 1/2"



**DOUBLE ACCESS DOORS**  
**MODEL:** 23930S  
**CUT-OUT:** 20 1/2" x 30"



**DOUBLE DOORS WITH DUAL DRAWERS AND TRASH TRAY**  
**MODEL:** 23930S-12  
**CUT-OUT:** 21" x 30 1/2" x 20 1/2"



**SINGLE DOOR WITH DUAL DRAWERS**  
**MODEL:** 23820-S  
**CUT-OUT:** 20 1/2" x 14 1/2" x 20 1/2"



**DRAWER WITH PROPANE DOOR ASSY**  
**MODEL:** 25914-S  
**CUT-OUT:** 27 3/4" x 14 1/2" x 20 1/2"



**VENTING PANEL, LOUVERED STAINLESS STEEL**  
**MODEL:** 5510-01  
**CUT-OUT:** 3 3/4" x 12 3/4"

*Also available: (not shown)*

- MODEL:** 23912-S **CUT-OUT:** 12 1/2" x 18 1/2"
- MODEL:** 23918-S **CUT-OUT:** 18 1/2" x 12 1/2"
- MODEL:** 23924-S **CUT-OUT:** 24 1/2" x 17 1/2"
- MODEL:** 23914-S **CUT-OUT:** 14 1/2" x 20 1/2"

\* Available in left or right hinge

## CARE AND CLEANING

Clean your unit by first using Fire Magic Barbecue and Grill Cleaner (part #3580-1) to remove grease and dirt. Always wipe with the grain (See Fig. 10-1). Next, use Fire Magic Stainless Steel Cleaner (3581-1) to restore the stainless steel color. Finish by wiping your unit down using Fire Magic Polish Wipes (3586-1).

If your unit is installed in a seaside (salt air) or poolside (chlorine) location, it will be more susceptible to corrosion and must be maintained/cleaned more frequently. Do not store chemicals (such as chlorine or fertilizer) near your stainless steel unit.

Due to the nature of stainless steel, surface iron oxide deposits may appear. Do not be alarmed – these deposits are removable with stainless-steel cleaner through prompt and periodic maintenance. If not attended to promptly, permanent pitting may occur.

By following these recommendations, you will enjoy the beauty and convenience of your unit for many years to come.

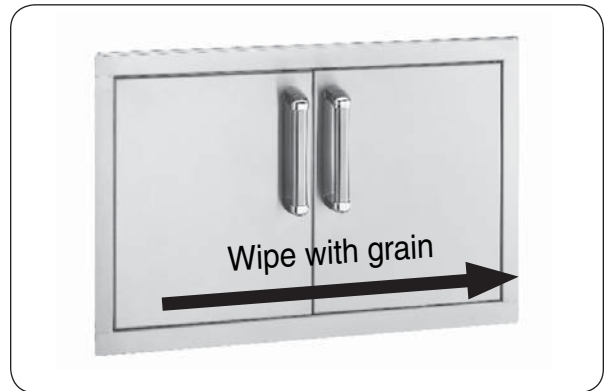

**Fig. 10-1**

# SAFE USE & MAINTENANCE OF PROPANE GAS CYLINDERS

## IMPORTANT FOR YOUR SAFETY

### READ AND FOLLOW ALL WARNINGS PROVIDED WITH THE PROPANE-GAS CYLINDER.

When operating this appliance with a propane-gas cylinder, these instructions and warnings **MUST** be observed.

**FAILURE TO DO SO MAY RESULT IN A SERIOUS FIRE OR EXPLOSION.**

## CYLINDER/CONNECTOR REQUIREMENTS

- Propane-gas cylinders, valves, and hoses must be maintained in good condition and must be replaced if there is visible damage to either the cylinder or valve. If the hose is cut or shows excessive abrasion or wear, it must be replaced before using the gas appliance (see e.).
- This unit, when used with a cylinder, should be connected to a standard 5-gallon (20 lb.) propane-gas cylinder equipped with an OPD (Overfill Prevention Device). The OPD has been required on all cylinders sold since October 1, 1998, to prevent overfilling.
- Cylinder dimensions should be approximately 12" (30.5 cm) in diameter and 18" (45.7 cm) high. Cylinders must be constructed and marked in accordance with the *Specifications for Propane Gas Cylinders of the U.S. Department of Transportation (D.O.T.)* or the National Standard of Canada, *CAN/CSA-B339, Cylinders, Spheres, and Tubes for Transportation of Dangerous Goods*.
- The cylinder used must include a collar to protect the cylinder valve, and the cylinder supply system must be arranged for vapor withdrawal.
- The pressure regulator and hose assembly used must match the specification for Type I by *ANSI Z 21.58-2005/CGA 1.6-2005* (see Fig. 11-1).
- The propane-gas cylinder valve must be equipped with a cylinder connection coupling device, described as Type I in the standard defined in paragraph e. above. This device is commonly described as an Acme thread quick coupler.
- If the propane-gas cylinder comes with a dust plug, place the dust cap on the cylinder valve outlet whenever the cylinder is not in use.

## QUICK COUPLER OPERATION

**To connect the regulator/hose assembly to the propane-gas cylinder valve fitting:** Press the hand nut on the regulator over the Acme thread fitting on the cylinder valve. Turn the hand nut clockwise to engage the threads and tighten until snug.

## ENCLOSURE REQUIREMENTS

**FOR YOUR SAFETY, you must provide the openings listed below for drainage, replacement air, and cross-ventilation of any storage area exposed to possible leakage from gas connections, the unit, or propane cylinders:**

One side of the gas cylinder enclosure left completely open to the outside **OR** by providing four (4) ventilation openings. Two (2) openings are to be at the cylinder valve level (approx. 16" [40.6 cm] above the floor) and on opposite walls of the enclosure. Two (2) more openings must be at the floor level on opposite sides of the enclosure. The floor-level openings must start at the floor and shall extend no higher than 5" (12.7 cm) above the floor. Each opening must have a minimum of 10 sq. in. (64.5 cm<sup>2</sup>) of free area. To achieve the proper ventilation, you may drill a series of holes, omit the grout from masonry joints, or replace a brick with a hardware cloth screen. If the floor in the cabinet is raised and the space beneath the cabinet is open to the outside, the lower ventilation openings may be in the floor.

Consult your gas supplier for ventilation and regulator requirements when connecting to a household propane supply.

The use of pliers or a wrench should not be necessary. Only cylinders marked "propane" may be used.

**To disconnect:** Turn the hand nut counterclockwise until detached (Fig. 11-1).

**Important:** Before using the unit, and after each time the cylinder is removed and reattached, check the hose for wear (see a.) and check all connections for leaks. Turn off the unit valves and open the main cylinder valve, then check connections with soapy water. Repair any leaks before lighting the unit.

**CAUTION:** Always turn the propane cylinder main valve off after each use, and before moving the unit and cylinder or disconnecting the coupling. This valve must remain closed and the cylinder disconnected while the appliance is not in use, even though the gas flow is stopped by a safety feature when the coupler is disconnected.

**Carefully** inspect the hose assembly each time before the gas is turned on. A cracked or frayed hose should be replaced immediately.

If the appliance is stored indoors, the cylinder must be disconnected and removed. Disconnected cylinders must be stored outdoors, out of the reach of children, with threaded valve plugs tightly installed, and must not be stored in a building, garage, or any other enclosed area.

## FOR YOUR SAFETY

- DO NOT store a spare propane-gas cylinder under or near this appliance.
- NEVER fill the cylinder beyond 80-percent full.
- IF THE INFORMATION IN a. AND b. IS NOT FOLLOWED EXACTLY, A FIRE CAUSING DEATH OR SERIOUS INJURY MAY OCCUR.

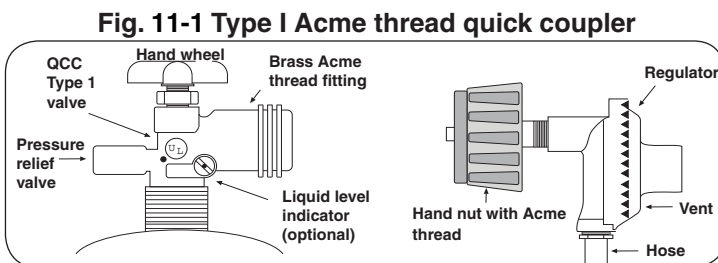

## NOTES PAGE

Please use this page to record any information about your door/drawer that you may want to have at hand.