

LYNX FREESTANDING 27" W/ DIMENSIONS

TOP VIEW

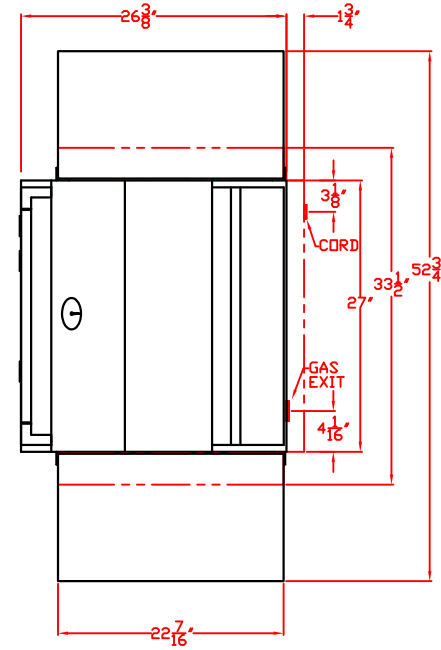

FRONT VIEW

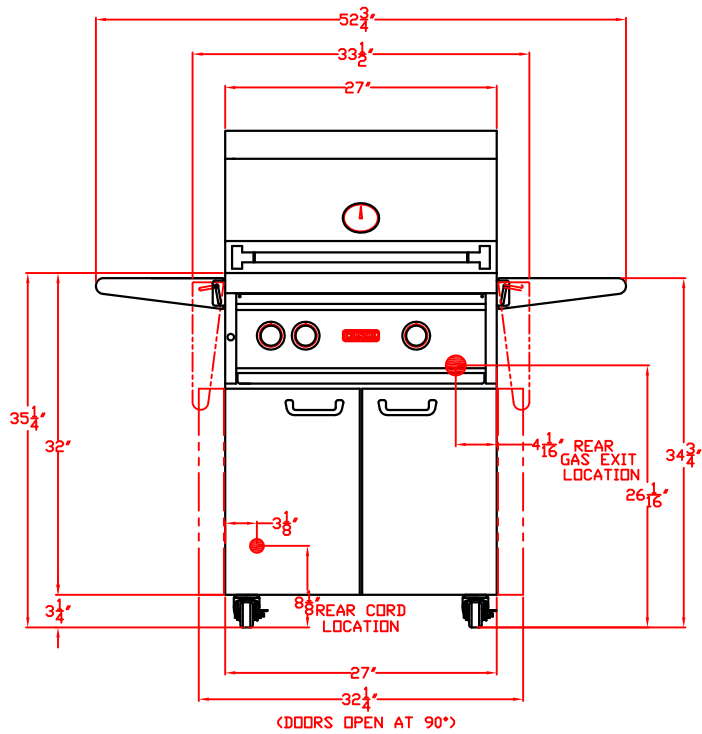

(DOORS OPEN AT 90°)

RIGHT SIDE VIEW

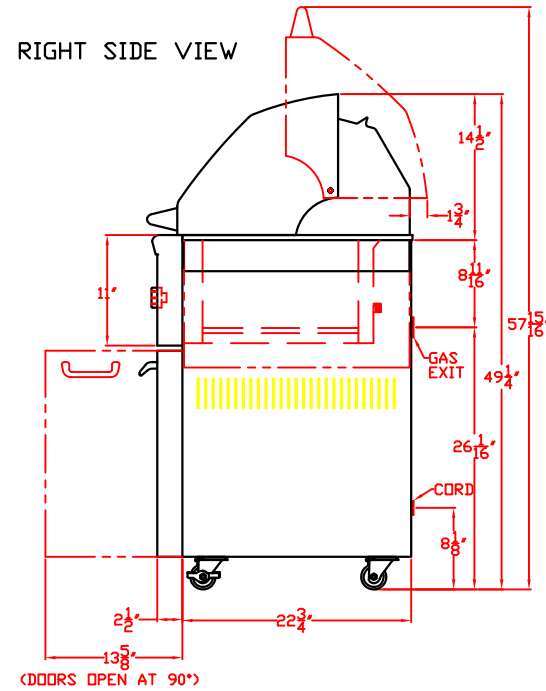

(DOORS OPEN AT 90°)